



1

THE BMW 8 SERIES COUPÉ



2

DESIGN AND HIGHLIGHTS

- 20 The Vision
- 22 Exterior design
- 24 Interior design
- 26 Dynamics BMW M8 GTE
- 28 Dynamics BMW M850i xDrive
- 30 Dynamics BMW 840i
- 32 Dynamics

3

INNOVATION AND TECHNOLOGY

- The Vision 34
- Driver assistance 36
- Connectivity and infotainment 38
- Comfort and functionality 40

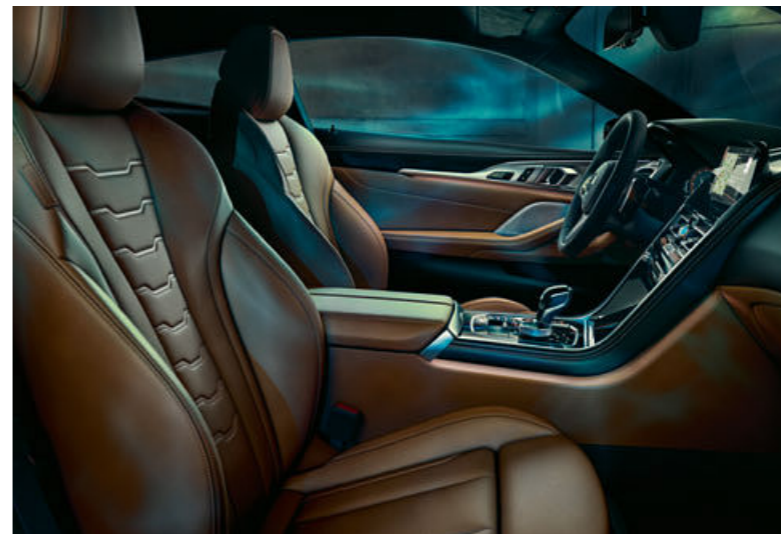

4

EQUIPMENT

- 42 The Vision
- 44 BMW Individual
- 46 Exterior colours
- 48 Interior colours
- 54 Technical data

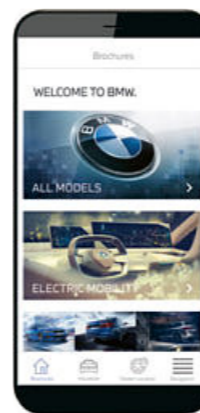

YOUR NEW SPEED DATING APP.

Download now the BMW Brochures app from your app store and discover driving pleasure!



Let's talk about courage,
and why we need it more than ever.

Courage is independent and disruptive.
Courage questions, shatters and awakens.

We need bold, courageous voices.
All of us.
We need fresh thinkers with optimism.

We believe in the frontrunners.
The avantgarde, those who fight stagnation
and backwardness.

Courage only knows moving forward.
Driving the pioneers of our culture
to inspire tomorrow.
To create a sublime kind of new.
Reaching a superior level of excellence.

This is where a
new kind of luxury is born.



EVERY DAY WE EXPERIENCE PROGRESS.
THE FUTURE. YET WE FEEL THAT WE HAVE
SEEN IT ALL BEFORE. NOW AND THEN THOUGH,
SOMETHING SURPRISES US. AND TOUCHES US.





POWER IS A PHYSICAL QUANTITY: ONLY WHEN YOU CULTIVATE IT, YOU CAN ADD A DIMENSION TO IT.





PURSuing HAPPINESS, SEARCHING FOR LOVE, CELEBRATING SUCCESSES, DEALING WITH SETBACKS, GOING FOR THE BEST, OPTIMISING, BRINGING TO PERFECTION - LETTING GO.

WE LIVE IN A TIME THAT IS ALL ABOUT SPEED,
ABOUT MILLISECONDS. A TIME THAT IS RUNNING
AWAY IF YOU ARE NOT CLOSE ON ITS HEELS.
UNLESS YOU SIMPLY OVERTAKE IT.





WHOEVER ONLY FOLLOWS TRACES,
REACHES PLACES WHERE MANY OTHERS
HAVE BEEN ALREADY. IT IS ABOUT TIME
TO LEAVE NEW TRACES.

YOUR DESTINATION MAY BE A LINE, A PLACE,
A PERSON, THE ROAD. AND SOMETIMES YOU
WILL ONLY KNOW WHEN YOU HAVE ARRIVED.



2

“LUXURY MUST AROUSE EMOTIONS.”

Searching and finding modern perfection: Adrian van Hooydonk, chief designer at the BMW Group, on the new appearance in the segment of the most exclusive vehicles.

The models under the name Bayerische Motoren Werke open up a new world within the BMW portfolio. What is your idea of contemporary luxury?

We do not want to tell our customers how they should define luxury for themselves, but just want to make an attractive, diverse offer. The perception of luxury is very different worldwide. But a central aspect that becomes visible everywhere is the increasing significance of personal time. It is becoming the most valuable asset in a globalised world.

How is the wish for perfection and refinement expressed in mobility?

In today's mobile world, we spend more and more time in various modes of transport. Cars are now like personal rooms on wheels. One wants to feel completely comfortable in them. A steering wheel that you touch, the materials

that surround you have to feel perfect and the eye does not want to be disturbed by unclear lines or individual components. The interior of a vehicle is seen as a living space. It is about being surrounded by the highest possible sensuous quality.

What is the biggest challenge in the external appearance?

Luxury must be reflected to the outside world in a matter-of-fact way. In English there is a beautiful term for it: sophistication. For designers – our team has more than 700 employees at four locations worldwide, who are encouraged through constant competition with each other in terms of ideas – this means that every detail counts. The design has to arouse strong emotions while expressing the highest quality and durability at the same time. In order to be able to spend every moment intensely, full of meaning and beauty. Therefore, we are building a luxury ecosystem, a model family. In various forms of expression: contemporary saloons, elegant and very sporty coupés, but also vehicles that offer very luxurious space.

In the new designs, a common factor is noticeable: the reduction of lines. Do you want to increase luxury by making luxury less apparent in the design?

In this way, the design becomes clearer, more modern and more emotional. An expressive surface play is in the foreground, and the dynamics are emphasised even more than before by the vehicle body. The few but very precise vehicle lines underline the graphic design of the surfaces. The vehicle body looks more powerful, refined and luscious with the lavish surfaces without losing the sportiness that is typical to BMW. This is possible only because we work out every feature of a vehicle individually. For a BMW, one should be able to identify at first glance what kind of experience one would have with it. Especially in our large and particularly luxurious vehicles, we attach great importance to a marked appearance and the maximum possible feel-good factor in the interior. It's about freedom – and the feeling of being at home in a BMW.





IN THE FORM OF LIFE.

The BMW 8 Series Coupé establishes a completely new design language for luxury sports cars – an overview of the most important design innovations.

POWERFUL PROPORTIONS.

Just right for a BMW sports car of the highest performance class: the sporty-powerful proportions. Deep, wide and ready to leap, the flat body ducks over the asphalt. Voluminous rear wheel arches emphasise a low centre of gravity and the classic rear-wheel drive. The flowing silhouette in conjunction with the gently curved surfaces thus signal an effortless and natural urge to move forward.

ADVANCED HALLMARKS.

The BMW designers interpreted well-known BMW design elements such as the BMW kidney grille, the rear lights in the shape of an L or the typical kink in the graphics of the rear windows in a highly modern way. For example, the forward leaning BMW kidney grille in the shape of a "shark nose" refers to iconic BMW racing cars such as the BMW 507 or BMW 3.0 CSL. The particularly delicate and wide rear lights featured in the BMW 8 Series Coupé emphasise the powerful shoulders as well as the powerful rear end.

CLEAR LINES.

The generously curved and muscular surfaces give the BMW 8 Series Coupé a particularly confident sportiness. The BMW designers have succeeded in reducing the number of lines along the bodywork to a radical minimum, thus emphasising the expressiveness of the surfaces to the maximum – the basis for a completely new silhouette in contemporary automotive design. Many surfaces, such as the gently raised flanks behind the air vents of the front wheel arches, have hitherto been unseen in such an expressive form in automotive design.



WIDE REAR LIGHTS IN THE BMW TYPICAL FORM OF AN L UNDERSCORE THE STRONG SHOULDERS OF THE BMW 8 SERIES COUPÉ.

PERFECTED DETAILS.

Other subtle details such as the minimalist and floating light side mirrors or the double-arched roof in the style of classic racing cars complete the harmonious overall impression of the BMW 8 Series Coupé, which, despite its restrained form and unobtrusive luxury, awakens the viewer's emotionalism typical of a BMW sports car.



THE LUXURY TO BE SPORTY.

The BMW 8 Series Coupé is also irresistibly luxurious in the interior – and at the same time inimitably sporty: Noble materials and elaborate workmanship create a maximally exclusive ambience. At the same time, however, the design of the BMW 8 Series Coupé is thoroughly dynamic in keeping with its character: The intentional longitudinal orientation of the interior allows all lines to thrust forward, and the BMW typical, consistent driver orientation helps to keep the driver in control of everything at all times. Get in and experience the feeling of the racetrack, elegantly interpreted.

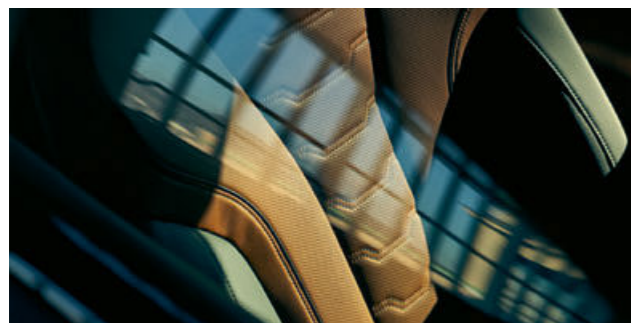

IN THE BMW INDIVIDUAL EXTENDED LEATHER TRIM 'MERINO' TARTUFO WITH STRIKING CONTRAST STITCHING, EVEN THE SEATS ATTRACT ATTENTION.

TWO WORLDS, NO COMPROMISES: THE BMW 8 SERIES COUPÉ COMBINES SPORTINESS WITH ABSOLUTE LUXURY.

From classic-sporty to modern-elegant: Even the interior has a unique luxurious atmosphere. Starting with the basic equipment, the instrument panel and door panel are covered in leather and provided with contrast stitching. Seats in leather 'Vernasca'^{3,*}, BMW Individual leather 'Merino' with extended contents^{1,2,*} or even BMW Individual full leather trim 'Merino'^{1,*} emphasise the individual claim of the interior. Design elements such as the flowing transitions between the instrument panel and the doors create an all-round exclusive design experience that equally surrounds drivers and passengers on all sides. The hand-crafted glass applications¹ are an experience for the hands and the eyes: They exclusive highlights to selected control elements such as the gear selector lever, the Start/Stop button and the iDrive controller, further enhancing the already sophisticated ambience.

¹ Available as optional equipment.

² Standard for BMW M850i xDrive.

³ For the driver and front passenger seat.

* The availability of some equipment features and functions depends on engine variants or additional options. The market and production availability may vary. You can find detailed information about terms, standard and optional equipment at www.bmw.com or at your BMW Partner.



ALUMINIUM TRACE DARK M INTERIOR TRIM^{1,2,*} CREATES DYNAMIC HIGHLIGHTS IN THE INTERIOR WITH A TECHNICAL TOUCH.

INSPIRED BY THE CIRCUIT – THE INTERIOR OF THE BMW 8 SERIES COUPÉ IS DYNAMIC TO THE LAST DETAIL.

In the BMW 8 Series Coupé, all the lines point forward from the driver's point of view and manifest the feeling of unrestrained forward thrust. Typically for a sports car, the centre console is wide and steeply rising. Here, all relevant functions are clearly summarised, so that the driver enjoys full control in every driving situation. In addition, the clearly structured layout creates space for the luxurious effect of the high-quality materials and spacious surfaces.

IRRESISTIBLY LUXURIOUS – AND INIMITABLY SPORTY AT THE SAME TIME.



SPARKLING EXCLUSIVITY: THE GLASS APPLICATIONS 'CRAFTED CLARITY' ARE MANUFACTURED BY HAND AND EMBELLISH SELECTED ELEMENTS IN THE INTERIOR.





NO COMPROMISES.

Respect. That's what I feel when I see the BMW M8 GTE. The BMW kidney grille, the rear end with wide wheelbase, the wheel arches and air outlets, and the overall aerodynamics radiate an intensity that shows every competitor what it's about on the racetrack: Respect.

Actually, tuning and engine power are the most important features of a vehicle for a professional racer. But these strengths must also be visible at first glance. In this regard, the BMW M8 GTE is the most consistent racing car BMW has ever built. And this presence is immediately apparent in the production model. The elongated bonnet and the proportions of the rear wheels immediately reveal the genes of a sports car – the sides of the production model are ultimately only 100 millimetres narrower than those of the BMW M8 GTE.

The development of a new racing car takes several years. As a driver you are involved, test, give feedback. And the experts work on the details, such as the shape of the exterior mirrors, which is based on the famous M hooks of the BMW M models and improves the flow on the sides of the vehicle. I was honoured to be the first to drive the

BMW M8 GTE on the racetrack after its development. An emotional moment – and from the first moment a perfect co-operation.

This wow effect was there in the production model immediately, you feel immediately embraced by the vehicle. You do not just sit in it and drive, you become a unit. Everything feels ergonomic. The structure of the cockpit, the settings on the steering wheel all show that no compromises are made when it comes to driver orientation. I feel the same absolute confidence that is so essential on the racetrack. When nothing should distract you, especially in a 24-hour race like Le Mans, when you have to go through the programme without a hitch. Hour after hour, lap after lap, to be fully there in the finale. Show strength when it's about everything – and show the competitors a very special design detail of the BMW 8 Series: the characteristically slim line of rear lights.



Martin Tomczyk.
The racing driver and long-distance specialist was closely involved in the development of the BMW M8 GTE. No other pilot has covered so many kilometres in the BMW M8 GTE.



**THE 19" M SPORT BRAKE^{1,2,*}
IMPRESSES WITH THE MOST
PRECISE DOSING AND HIGHEST
BRAKING PERFORMANCE – EVEN
UNDER THE TOUGHEST LOAD.**

¹ Available as optional equipment.
² Standard for BMW M850i xDrive.
* The availability of some equipment features and functions depends on engine variants or additional options. The market and production availability may vary. You can find detailed information about terms, standard and optional equipment at www.bmw.com or at your BMW Partner.

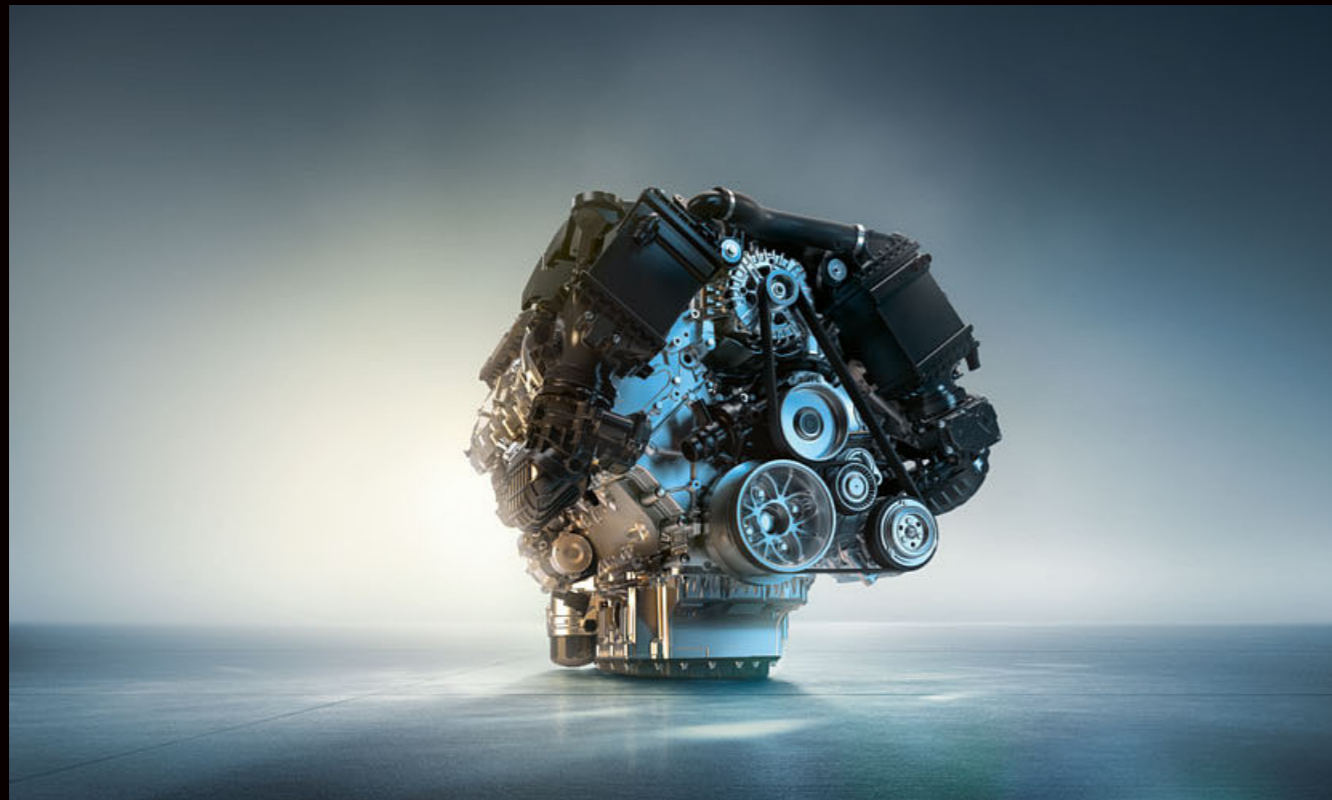

HIGH PRECISION INJECTION WITH UP TO 350 BAR, DOUBLE-VANOS AND VALVETRONIC SET STANDARDS IN PERFORMANCE AND EFFICIENCY.

AT HOME NEAR THE LIMITS: THE BMW M850i xDRIVE COUPÉ.

A push on the gas pedal – and the BMW TwinPower Turbo 8-cylinder petrol engine with 4.4 litre capacity resolutely attacks every metre of asphalt. Its superior revving power drives up the driver's pulse when it approaches the tangible limit with precise dosing: Two TwinScroll exhaust gas turbochargers, cylinder liners with special coating and a cooling package designed for maximum performance with two repositioned coolers, an upstream radiator and a 1,000-watt fan are only found in racing sports cars. On request, the Sport exhaust system emphasises the load changes of the V8 engine with a strong character, but at the push of a button it also has a finely subdued tone – depending on the selected mode.

A PUSH ON THE GAS PEDAL – AND THE BMW TWIN POWER TURBO 8-CYLINDER PETROL ENGINE WITH 4.4 LITRE CAPACITY RESOLUTELY ATTACKS EVERY METRE OF ASPHALT.

SUPERIOR ENGINEERING: THE BMW TWIN POWER TURBO V8 PETROL ENGINE FORMS THE POWERFUL HEART OF THE BMW M850i xDRIVE.



¹ Available as optional equipment.
² Equipment exclusively available for BMW M850i xDrive.

Further information on fuel consumption and CO₂ emissions can be found in technical data.

INNOVATION FROM RACING. FOR HIGH PERFORMANCE ON THE ROAD.

The racing genes of the BMW M850i xDrive Coupé are noticeable in every driving situation. The high body rigidity and the reinforced suspension components ensure direct implementation of every steering command. The specially-tuned BMW xDrive four-wheel drive and the controlled M Sport differential provide maximum traction when accelerating out of corners – with an agility that was previously reserved only for rear-wheel drive vehicles. The 19" M Sport brake impresses with the most precise dosing and highest braking performance – even under the toughest load. Maximum lateral forces are counteracted by the wheels with standard sport mixed tyres. Integral Active Steering guarantees perfect steering and maximum speed confidence in every speed range. As standard, the BMW 8 Series Coupé comes with the Adaptive M suspension. It provides optimum road holding on all surfaces and allows the driver to choose between particularly sporty or comfortable suspension tuning. Welcome to a new dimension of performance!

CONFIDENT THROUGH EVERY CURVE – AT ANY SPEED: ADAPTIVE M SUSPENSION PROFESSIONAL.

Highly agile, surprisingly comfortable: The Adaptive M suspension Professional^{1,2} combines typical dynamics with smoothness and stability. The electromechanical body roll stabilisation reduces the lateral inclination on the curves and thus enables very high cornering speeds. Depending on the situation, it chooses a stabilising or agile driving behaviour. Thus, the driver can enjoy the fullest control and responsive handling even with fast cornering or quick changes of direction.

THROUGH THE ADAPTIVE M SUSPENSION PROFESSIONAL AND THE LATEST-GENERATION BMW xDRIVE, THE BMW M850i xDRIVE COUPÉ IS EXCEPTIONALLY SPORTY AND ALSO COMFORTABLE.



390 kW

(530 hp) output

3.8 s

0 to 100 km/h

4,395 cm³

Capacity

750 Nm

Torque

THE ONLY ONE OF ITS KIND. WITH CLASSIC REAR-WHEEL DRIVE.

Something for purists: The BMW 840i Coupé is for those who appreciate the classic virtues of a sports car powered exclusively by the rear wheels. Connoisseurs do not want to do without this unique driving feeling – and experience it in this exceptional vehicle in an excitingly sporty way.

EXCITING SPORTS CAR FEELING. REINTERPRETED.

The new 840i engine of the BMW 8 Series Coupé makes the heart of every sports car enthusiast beat faster from the very first contact. Thanks to the BMW TwinPower Turbo 6-cylinder petrol engine, the entire power of this elegant vehicle is unleashed when the accelerator pedal is briefly pressed, catapulting this exceptional vehicle forward. Extremely sprint-friendly and confident up to high rev ranges, this engine shows the purest form of all qualities that make a BMW engine so extraordinary. Depending on the selected driving experience mode, the experience extends from dynamic to maximum sporty – a characteristic feature that becomes an experience even for the ears thanks to the unique sound of the BMW TwinPower Turbo 6-cylinder petrol engine.

POWERFUL AND DYNAMIC – WITH REAR-WHEEL DRIVE.

If you're looking for a pure sports car experience, choose the rear-wheel drive version of the BMW 840i. This is the only model in the 8 Series to transmit all the thrust of its powerful engine to the rear axle. Thanks to a lower total weight and an optimised weight distribution, this uncompromisingly sporty drive variant also ensures an exciting maximum of performance and dynamics. The pure experience of classic racing, euphorically interpreted – in the BMW 840i Coupé with rear-wheel drive. The new BMW TwinPower Turbo 6-cylinder petrol engine is also available with BMW xDrive intelligent all-wheel drive, which combines sportiness and driving comfort.

245 kW

(333 hp) output

5.2 s

0 to 100 km/h

2,998 cm³

Capacity

500 Nm

Torque



CLASSY ROAD HOLDING IN EVERY SITUATION COMBINED WITH MAXIMUM FORWARD THRUST: THE BMW 840i DOMINATES EVERY STREET THAT IT TRAVELS ON.

EVERY TURN IS ANOTHER TRIUMPH:

The M Sport differential ensures that even with challenging changes of direction or on various surfaces, the engine power is optimally brought to the road. A permanent, continuously electronically controlled multi-disc lock, which was developed for motor sports, reduces any speed differences between the rear wheels and distributes the drive torque variably between them. Depending on the setting, this makes it possible to achieve a driving experience that covers the entire range from traction-oriented to maximum driving dynamics and sportiness – but ensures maximum driving pleasure in every respect.

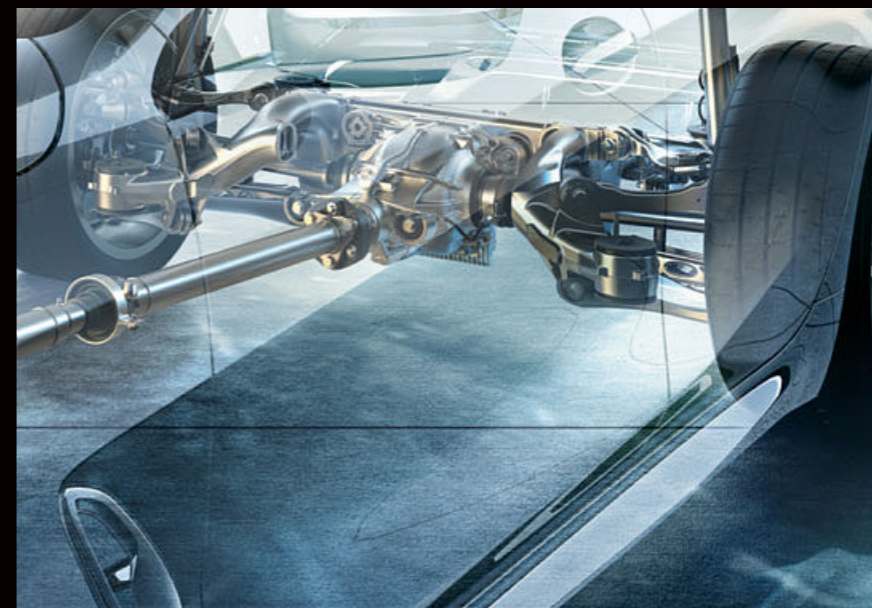

THE INCOMPARABLY PURE EXPERIENCE OF A CLASSIC REAR-WHEEL DRIVE – IN THE BMW 840i COUPÉ, IT BECOMES EVIDENT AS TO HOW MUCH ADRENALIN THIS TYPE OF DRIVE GENERATES.



“Doppia Gobba” – double curvature also in the carbon-fibre roof

Aerodynamic exterior mirrors

Low centre of gravity and extremely flat headlights

Large air intakes at the front

THE ELECTRICALLY ADJUSTABLE EXTERIOR MIRRORS ARE ESPECIALLY SPORTY WITH CARBON-FIBRE MIRROR CAPS. THEY ARE DESIGNED TO OPTIMISE THE AERODYNAMICS OF THE BMW 8 SERIES COUPÉ.

AN IMPRESSION THAT LASTS FOREVER.

The BMW M850i xDrive is not only fast, it also looks fast. Its design shows uncompromising dynamics and makes a statement that leaves no questions unanswered: painted in Sunset Orange¹ and finished with carbon-fibre elements, this is a pure-bred sports car that does not want to stand still on its 20" M light alloy wheels, but drive – gentlemen, start your engines!

THE MULTI-ADJUSTABLE M SPORT SEATS WITH BUCKET SEAT CHARACTER AND PARTLY INTEGRATED HEADREST PROVIDE EXCELLENT LATERAL SUPPORT FOR YOU AND YOUR FRONT PASSENGER.



MORE CARBON-FIBRE FOR MORE LIGHTNESS: THE M CARBON PACKAGE FOR THE EXTERIOR AND THE M CARBON-FIBRE ROOF.

Carbon-fibre in every detail: The exclusive M carbon exterior package¹ * adds numerous design elements made of carbon-fibre to the already standard integrated carbon core components of the BMW 8 Series Coupé – for a more thoroughbred sports car look that draws everyone's attention. With mirror caps, air intakes, a decorative element around the tailpipe trims, an M rear spoiler made of carbon-fibre and a sharpened rear diffuser, the carbon exterior package reinforces the motor sport character not only visually, but also substantially. The M carbon-fibre roof¹ * also makes a clear statement for a philosophy that gets the most out of everything – ideal conditions for those who want to experience maximum dynamics on every journey.

A PUREBRED SPORTS CAR THAT DOES NOT WANT TO STAND STILL, BUT BE DRIVEN – GENTLEMEN, START YOUR ENGINES!

THE M CARBON-FIBRE ROOF MADE FROM THE ULTRA-LIGHT, BUT HIGHLY STABLE MATERIAL, RAISES THE ADRENALINE-DRIVEN LOOK OF THE BMW M850i xDRIVE TO A NEW LEVEL.



¹ Available as optional equipment.
* The availability of some equipment features and functions depends on engine variants or additional options. The market and production availability may vary. You can find detailed information about terms, standard and optional equipment at www.bmw.com or at your BMW Partner.

3

EMOTION EXPRESSED AS INNOVATION.

Thoughts were born, ideas thought through and know-how taken to the extreme. Innovative technologies were developed, comfort and efficiency enhanced and performance levels increased. But all this was not done to put knowledge, ability and pioneering spirit in the foreground – but to make this one, special feeling even more tangible: Driving pleasure. Technology becomes emotion – the BMW 8 Series Coupé.



THE IDEA OF DRIVING: THOUGHT THROUGH.

DRIVER ASSISTANCE

Moving toward the autonomous driving of the future, innovative BMW driver assistance systems already offer a high number of intelligent semi-automated systems that support the driver in monotonous, demanding or confusing situations. Whether activated on request or as an assistant in the background, BMW assistance systems make driving and parking the BMW 8 Series Coupé safer, more comfortable and more relaxed.



THE AUTOMATIC SPEED LIMIT ASSIST¹* ADAPTS THE ACTIVE CRUISE CONTROL DYNAMICALLY TO UPCOMING SPEED LIMITS.

THE SAFETY PACKAGE DRIVING ASSISTANT^{1,2}* SUPPORTS YOU IN NUMEROUS DANGEROUS DRIVING SITUATIONS, AND BRAKES AUTOMATICALLY IN CASE OF AN EMERGENCY.

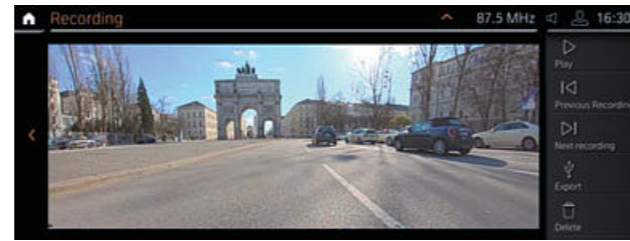

BMW DRIVE RECORDER

The BMW Drive Recorder¹* allows you to record a video from the vehicle environment and play the video on the central Control Display or via USB export also on your device. Important vehicle information such as speed and GPS position are stored synchronously with the video. The BMW Drive Recorder has two sub-functions, the Event Recorder and the Crash Recorder.

IS THERE WHEN REQUIRED: DRIVING ASSISTANT PROFESSIONAL.

Driving Assistant Professional^{1,2}* offers optimum comfort and safety during critical or monotonous traffic situations. Apart from the contents of the Driving Assistant, it also includes Steering and Lane Control Assistant with extended functions, Emergency Stop Assistant and Lane Keeping Assistant with active side collision protection.

¹ Available as optional equipment.

² Function may be limited in darkness, fog or bright glare.

* The availability of some equipment features and functions depends on engine variants or additional options. The market and production availability may vary. You can find detailed information about terms, standard and optional equipment at www.bmw.com or at your BMW Partner.





CREATES NEW REALITIES.

CONNECTIVITY AND INFOTAINMENT



THE BMW HEAD-UP DISPLAY¹ TRANSMITS RELEVANT DRIVING INFORMATION INTO THE DRIVER'S LINE OF VISION WITHOUT DISTRACTION.

INNOVATIVE INFORMATION: BMW LIVE COCKPIT PROFESSIONAL WITH INNOVATIVE OPERATING CONCEPT.

The innovative BMW Live Cockpit Professional is the central element of interaction with the BMW 8 Series Coupé. On its display cluster, consisting of the Control Display in the centre console, the instrument display behind the steering wheel, and the BMW Head-Up Display, all information is presented in an appealing, clear and highly visible manner – so that the currently required information is always available. This is ensured by the innovative operating concept of the BMW Operating System 7: It can be operated completely intuitively by gesture, speech, touch or iDrive control. It can be individually configured – because the focus is always on the wishes of the driver and his passengers. To ensure that the driver can concentrate fully on the driving situation at the same time, the Head-Up Display projects information relevant to driving into his field of vision without distraction. And to ensure that the software of the BMW 8 Series Coupé is always up to date, it is simply installed over the air via Remote Software Upgrade – conveniently and stress-free, without having to visit your BMW service partner.

It is clear: The BMW 8 Series Coupé also ushers in a new era when it comes to connectivity. The innovations are BMW Live Cockpit Professional and BMW Operating System 7: a high-quality display cluster consisting of a touch-enabled, high-resolution 10.25" Control Display and a fully digital 12.3" instrument display, on which the innovative operating concept runs with intuitive operation via gestures, voice and touch control and numerous options for customising all displays.

"HEY BMW": THE BMW INTELLIGENT PERSONAL ASSISTANT.

Wouldn't it be incredible if your BMW was also your personal vehicle expert? Communicate with your vehicle using the BMW Intelligent Personal Assistant*. Say natural commands to operate numerous vehicle functions. It can also explain topics about your vehicle and helps you to get to know your BMW even better.



THE USER INTERFACE ALLOWS INTUITIVE OPERATION AND CAN BE ADJUSTED TO YOUR OWN REQUIREMENTS WITH VARIABLE WIDGETS.



¹ The information in the BMW Head-Up Display is not fully visible when viewed through polarised sunglasses. Content shown will depend on the equipment options chosen. Further optional equipment is required to display specific items.
* The availability of some equipment features and functions depends on engine variants or additional options. The market and production availability may vary. You can find detailed information about terms, standard and optional equipment at www.bmw.com or at your BMW Partner.

Some ConnectedDrive Services may differ between countries. Please consult your local BMW partner for more information.

SURPRISES. AND TOUCHES.

COMFORT AND FUNCTIONALITY



The comfort in the BMW 8 Series Coupé does not start when driving, but already when you get inside the car with the Comfort access¹ system. You do not need a key anymore to unlock the car, because your smartphone takes over this function with the BMW Digital Key^{1,3,*}. Once you hold it to the door handle, the doors are unlocked. Inside, the dynamic interior lighting welcomes you with a welcome scene, and the Bowers & Wilkins Diamond surround sound system surrounds you with crystal clear sound. The perfect way to tune in with what follows: an exciting driving experience that starts even before the BMW 8 Series Coupé moves.

SMOOTHED SOUND FOR PURE SOUND ENJOYMENT: THE BOWERS & WILKINS DIAMOND SURROUND SOUND SYSTEM.

Seven aluminium aramid-fibre midrange speakers. Four aluminium tweeters. Three diamond tweeters. Two subwoofers with Rohacell core. In addition a 10-channel amplifier and a microphone-supported dynamic driving sound regulation, which supplies excellent sound through discreet control of the loudspeakers in each driving situation: The Bowers & Wilkins Diamond surround sound system¹ blends selected materials and high-end technology to create a unique, high-end audio experience.

A FEAST FOR THE EYES: THE DYNAMIC INTERIOR LIGHTING.

The dynamic interior lighting immerses the interior in an unparalleled atmosphere that combines the best of ambient, indirect lighting with highlights. Numerous LEDs and optical fibres can be controlled in several adjustable colours. When entering and exiting or during events such as a telephone call, preconfigured, dynamic lighting effects create an eye-catching visual experience through the harmonious interaction of all lighting elements.

POSTURE NEEDS SUPPORT: MULTIFUNCTION SEATS.

Sportiness with a luxurious definition: The multifunction seats^{1,2,*} of the BMW 8 Series Coupé exceed all requirements that can be demanded from a sporty seat. The extra low seating position with a raised shoulder area and integrated headrest allows the driver to confidently sit in the centre of the power, while the comfortable seat adjustment with extensive electrical adjustment options ensures maximum lateral support. The active seat ventilation^{1,*} on the other hand ensures an ideal seat climate at all times, while striking stitching, the perforation and exclusive contrast stitching also perfect the overall seating experience visually.

¹ Available as optional equipment.

² Standard for BMW M850i xDrive.

³ Prerequisite is a BMW ConnectedDrive account and a compatible smartphone. For customers with a non-compatible smartphone, a high-quality Key Card is provided. More information about the BMW Digital Key, e.g. regarding the compatibility of your smartphone, is available at www.bmw.com/digitalkey

* The availability of some equipment features and functions depends on engine variants or additional options. The market and production availability may vary. You can find detailed information about terms, standard and optional equipment at www.bmw.com or at your BMW Partner.

Some ConnectedDrive Services may differ between countries. Please consult your local BMW partner for more information.



4

ONLY YOUR OWN WAY LEADS TO YOUR OWN GOALS.

Materials – hand crafted, exquisite and exclusive. Colours, surfaces and shapes as individual as the eyes that look upon it. Ideas and expectations are met without compromise – and exceeded. Design, detail and dynamics are aspects of one and the same idea – in the BMW 8 Series Coupé.

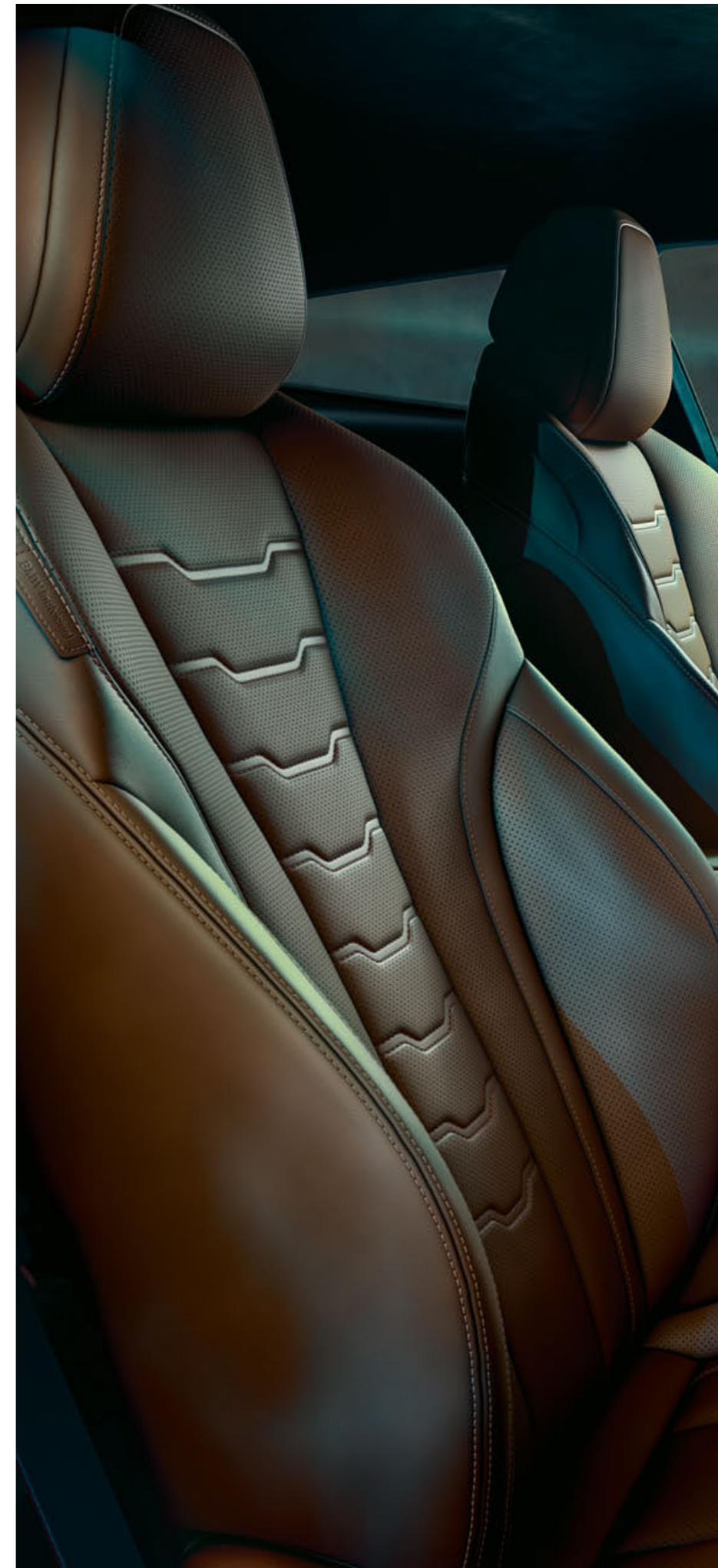

BMW INDIVIDUAL.

THE EXPRESSION OF PERSONALITY.



In the special paintwork Pure metal silver, chiaroscuro contrasts create the impression of molten metal. This is ensured by a base coat with the finest aluminium nanoparticles, which are ground and polished to the highest technical precision, as well as a second continuous paint coat including a finish. The overall result: A paintwork full of colour brilliance and deep gloss that attracts all the attention.



First of all, several layers of wood veneer are applied to the BMW Individual interior trim finishers in piano finish Black, which are varnished in numerous layers with piano finish and polished until a deep, high-gloss effect has been achieved. In the interior they spread a powerful, noble atmosphere.

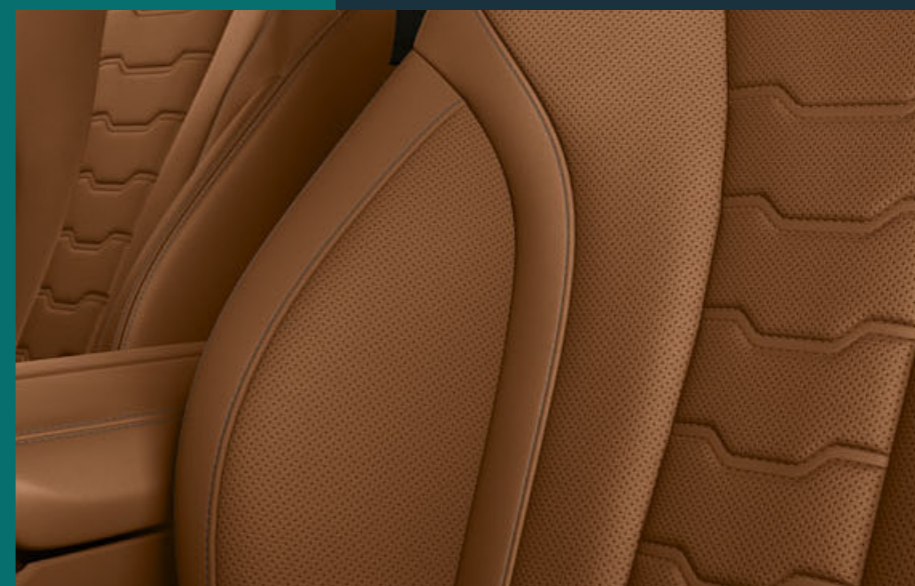

The BMW Individual extended leather upholstery 'Merino' in Cognac illustrates the claim to excellence of BMW Individual: Only premium quality leather without any surface defects is used, which is not subjected to any artificial embossing or surface treatment during the production process after an elaborate dyeing through barrel pigmentation.

To drive the BMW 8 Series Coupé means to follow your automotive dreams and not to compromise. BMW Individual enables you to make the exclusive even more extraordinary. Take your time and choose the most exquisite exterior and interior equipment options to suit your personal vision in an ideal way. Or go further and create your own version of the BMW 8 Series Coupé: in principle, everything is possible that is conceivable – that is precisely why it says: BMW Individual.

WHICH COLOUR GIVES YOU DRIVING PLEASURE?

EXTERIOR COLOURS

Barcelona Blue or Sunset Orange? Sapphire Black or Dravit Grey? The extroverted metallic colour palette for the BMW 8 Series Coupé will leave you spoiled for choice. For whichever paintwork you decide: You always choose ground-breaking design and uncompromising dynamics, which prove passion and character.

■ STANDARD EQUIPMENT □ OPTIONAL EQUIPMENT



■ Non-metallic 300 Alpine White²



□ Metallic A96 Mineral White¹

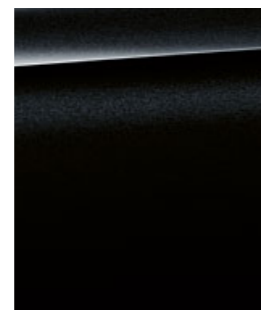

□ Metallic 475 Sapphire Black¹

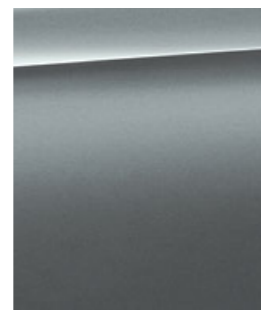

□ Metallic C2Y Bluestone¹

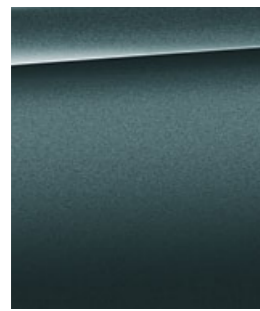

□ Metallic C35 Blue Ridge Mountain²

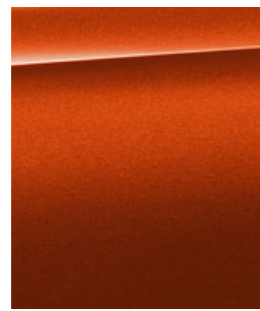

□ Metallic C1X Sunset Orange¹

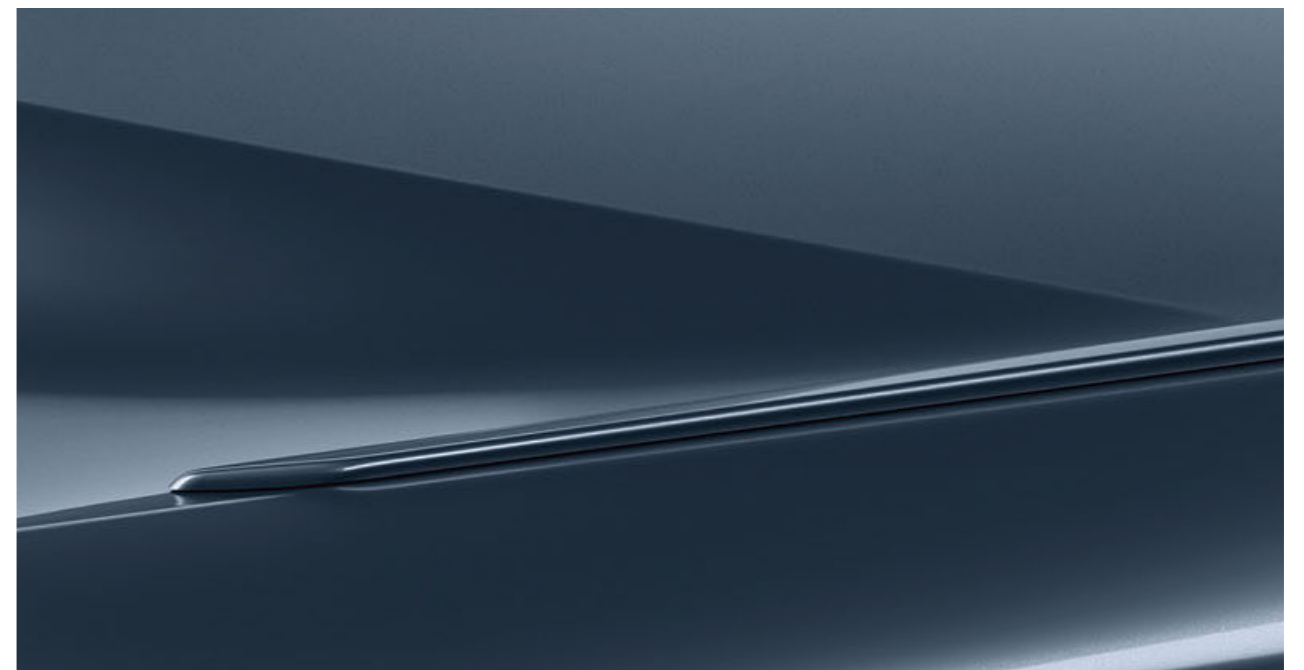

BMW INDIVIDUAL



□ BMW Individual C36 Dravit Grey metallic¹



□ BMW Individual X1C Aventurine Red metallic¹

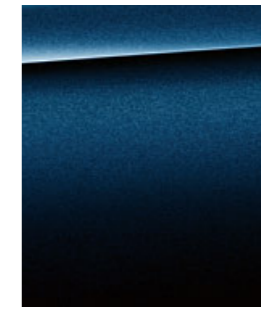

□ BMW Individual C3Z Tanzanite Blue metallic¹



□ BMW Individual X1D Frozen Bluestone metallic¹



□ BMW Individual special paintwork Brilliant White metallic¹



□ BMW Individual special paintwork Pure metal Silver¹



□ BMW Individual special paintwork Frozen Cashmere Silver metallic¹



□ BMW Individual special paintwork Frozen Brilliant White metallic¹



□ BMW Individual special paintwork Frozen Dark Silver metallic¹

M SPORT PACKAGE



□ Metallic C38 M Barcelona Blue¹

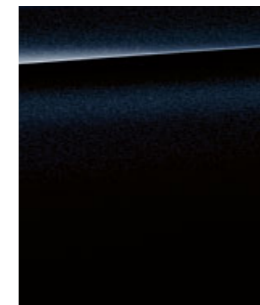

□ Metallic 416 M Carbon Black¹

[Colour samples] These colour samples are intended as an initial guide to the colours and materials available for your BMW. However, experience has shown that printed versions of paint, upholstery and interior trim colours cannot in all cases faithfully reproduce the appearance of the original colour. Please discuss your preferred colour choices with your BMW partner or dealership. There you can also see original samples and be assisted with special requests.

¹ Optionally also available with the M Sport package and M850i xDrive.

² Available as standard with the M Sport package and M850i xDrive.

³ Not available in conjunction with M Sport package or BMW Individual Composition with M Sport features.

The availability of some equipment features and functions depends on engine variants or additional options. The market and production availability may vary. You can find detailed information about terms, standard and optional equipment at www.bmw.com or at your BMW Partner.

STYLE AND PERFECTION.

UNIQUE IN TWO COLOURS



THE BMW INDIVIDUAL INTERIOR TRIM FINISHERS IN BLACK PIANO FINISH ADDITIONALLY ENHANCE THE LUXURIOUS CHARACTER.

When infallible style meets racing dynamics, the result is stunning: The extended leather trim BMW Individual 'Merino' in Bicolour Tartufo and Black^{1,*}, along with the BMW Individual interior trim finishers in piano finish Black, conveys confidence and an exciting sports car feel alike.



THE DYED, SOFT LEATHER FROM THE EXTENDED BMW INDIVIDUAL EXTENDED LEATHER TRIM 'MERINO' COMBINES THE TWO COLOURS TARTUFO AND BLACK INTO AN INTERPLAY OF BRIGHT AND DARK WITH A STRONG CHARACTER.

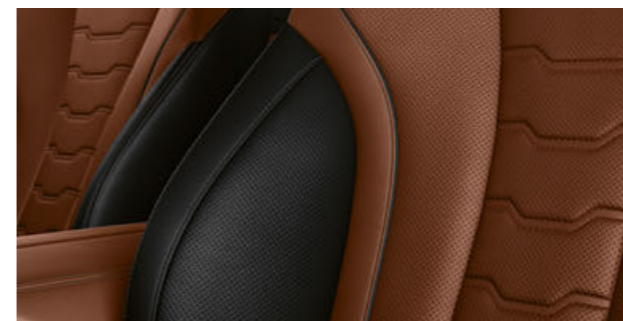

¹ Available as optional equipment.
^{*} The availability of some equipment features and functions depends on engine variants or additional options. The market and production availability may vary. You can find detailed information about terms, standard and optional equipment at www.bmw.com or at your BMW Partner.

UNDILUTED ADRENALINE.

STRONG CONTRAST, UNCOMPROMISING



THE INTERIOR TRIM FINISHERS IN PIANO FINISH BLACK APPEAR EXTREMELY EXQUISITE WITH THEIR GLOSS AND PICK UP THE CONTRAST OF THE UPHOLSTERY.

With the extended leather trim BMW Individual 'Merino' Bicolour in Fiona Red and Black^{1,*}, the interior of the BMW 8 Series Coupé is already enhancing the pulse. Along with the interior trim finishers in BMW Individual piano finish Black, there is no doubt about it: In this vehicle, limits are only starting lines.

THE INTERACTION OF STITCHING, PERFORATION AND SEAM PATTERN IS AN EXCLUSIVE FEATURE OF THE BMW 8 SERIES COUPÉ.

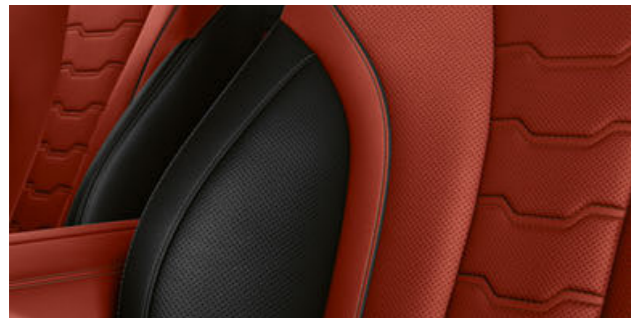

¹ Available as optional equipment.
^{*} The availability of some equipment features and functions depends on engine variants or additional options. The market and production availability may vary. You can find detailed information about terms, standard and optional equipment at www.bmw.com or at your BMW Partner.

LUXURY, ACCELERATED.

IVORY WHITE MEETS PIANO FINISH

Thoroughly elegant, unmistakably sporty: The interior in the bright colour scheme with BMW Individual full leather trim 'Merino' Ivory White^{1,*} and BMW Individual interior trim finishers in piano finish Black spread a luxuriously tasteful ambience in every detail.



THE SPECIAL SHINE MAKES THE BMW INDIVIDUAL INTERIOR TRIM FINISHERS IN PIANO FINISH BLACK APPEAR ESPECIALLY LUXURIOUS IN AN UNMISTAKABLE ENVIRONMENT.



THE STRIKING STITCHING HIGHLIGHTS THE BMW INDIVIDUAL FULL LEATHER TRIM 'MERINO' AND GOES PARTICULARLY WELL WITH THE IVORY WHITE UPHOLSTERY.

THE MOST PERSONAL WAY TO SHOW STYLE.

INTERIOR COLOURS

Be it 'Vernasca' leather in Cognac¹ combined with the interior trim finisher in Aluminium 'Mesheffect' dark or another exquisite combination – a harmonious interplay of colours and materials in the interior will be your companion on all journeys.

■ STANDARD EQUIPMENT □ OPTIONAL EQUIPMENT

LEATHER

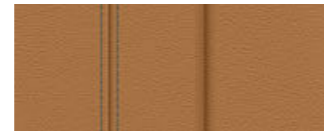

■ Leather 'Vernasca' MARI Cognac, interior colour Black^{1,*}

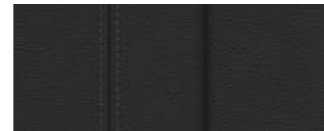

■ Leather 'Vernasca' MASW Black, interior colour Black^{1,*}



■ Leather 'Vernasca' MAEX Ivory White, interior colour Ivory White^{1,*}



□ Leather 'Merino' LKMI with extended features black, M piping accent^{2,*}

INTERIOR TRIM FINISHERS

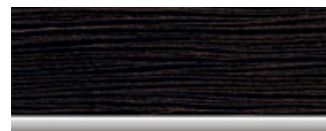

□ Interior trim finishers fine-wood trim 'Fineline' copper effect high-gloss on the centre console



□ Fine-wood interior trim finishers Ash Grain Grey Metallic high-gloss on the centre console

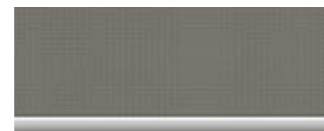

■ Interior trim finishers Aluminium 'Mesheffect' dark on the centre console



■ Aluminium Trace dark M interior trim strips on centre console²

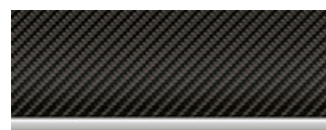

□ Interior trim finishers 'Carbon Fibre' on the centre console²

BMW INDIVIDUAL LEATHER



□ BMW Individual extended leather trim 'Merino' VASW Black, interior colour Black^{*}



□ BMW Individual extended leather trim 'Merino' VAHX Night Blue/Black, interior colour Black^{*}



□ BMW Individual extended leather trim 'Merino' VAHY Tartufo/Black, interior colour Black^{*}



□ BMW Individual extended leather trim 'Merino' VAHZ Fiona Red/Black, interior colour Black^{*}



□ BMW Individual extended leather trim 'Merino' VARI Cognac, interior colour Black^{*}



□ BMW Individual extended leather trim 'Merino' VAEX Ivory White, interior colour Ivory White^{*}



□ BMW Individual full leather trim 'Merino' ZBSW Black, interior colour black^{*}



□ BMW Individual full leather trim 'Merino' ZBHX Midnight blue/Black, interior colour Black^{*}



□ BMW Individual full leather trim 'Merino' ZBHZ Fiona Red/Black, interior colour Black^{*}



□ BMW Individual full leather trim 'Merino' ZBHY Tartufo/Black, interior colour Black^{*}



□ BMW Individual full leather trim 'Merino' ZBRI Cognac, interior colour Black^{*}

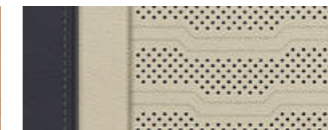

□ BMW Individual full leather trim 'Merino' ZBEI Ivory White/Midnight blue, interior colour Ivory White^{*}



□ BMW Individual full leather trim 'Merino' ZBEJ Ivory White/Tartufo, interior colour Tartufo^{*}

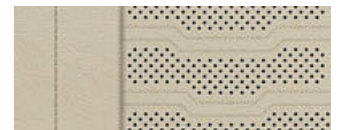

□ BMW Individual full leather trim 'Merino' ZBEX Ivory White, interior colour Ivory White^{*}

M HEADLINER



□ M headliner 775 Anthracite



□ M headliner 776 Alcantara Anthracite



□ M headliner XD5 Alcantara Midnight Blue^{*}

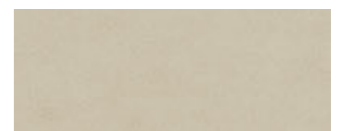

□ M headliner XD5 Alcantara Ivory White^{*}

BMW INDIVIDUAL INTERIOR TRIM FINISHERS



□ BMW Individual interior trim finishers piano finish Black on the centre console



□ BMW Individual fine-wood interior trim finisher strips Ash Black Silver effect high-gloss on the centre console

¹ For the driver and front passenger seat.

² Exclusively available for the M Sport package.

* The availability of some equipment features and functions depends on engine variants or additional options. The market and production availability may vary. You can find detailed information about terms, standard and optional equipment at www.bmw.com or at your BMW Partner.

TECHNICAL DATA.

		840i	840i xDrive	M850i xDrive	840d xDrive ⁵ with mild hybrid technology
Weight					
Unladen weight EU ¹	kg	1805	1870	2005	1990
Maximum permissible weight	kg	2225	2280	2395	2410
Permitted load	kg	495	485	465	495
Luggage capacity	l	420	420	420	420
BMW TwinPower Turbo engine³					
Cylinders/valves		6/4	6/4	8/4	6/4
Capacity	cm ³	2998	2998	4395	2993
Max. output/engine speed	kW (hp)/rpm	245 (333)/5500–6250	245 (333)/5500–6250	390 (530)/5500–6000	250 (340)/4400
With mild hybrid technology	kW (hp)	–	–	–	+8 (11)
Max. torque/engine speed	Nm/rpm	500/1700–4000	500/1700–4000	750/1800–4600	700/1750–2250
Power transmission					
Type of drive		Rear-wheel	All-wheel	All-wheel	All-wheel
Standard transmission		Steptronic Sport transmission	Steptronic Sport transmission	Steptronic Sport transmission	Steptronic Sport transmission
Driving performance					
Top speed	km/h	250 ²	250 ²	250 ²	250 ²
Acceleration 0–100 km/h	s	5.2	4.9	3.8	4.8
Consumption^{3,4} – All engines conform to the EU6 standard					
Urban	l/100 km	9.1–9.5	9.3–9.9	13.8–14.0	6.9–7.3
Extra-urban	l/100 km	5.7–6.0	6.4–6.6	7.6–7.7	4.6–5.0
Combined	l/100 km	7.0–7.3	7.5–7.8	9.9–10.0	5.4–5.8
Exhaust emissions standard (type-certified)		EU6d	EU6d	EU6d	EU6d
Combined CO ₂ emissions	g/km	160–168	172–180	228–230	143–154
Tank capacity, approx.	l	68	68	68	66
Wheels/tyres					
Tyre dimensions		245/45 R18 Y 275/40 R18 Y	245/45 R18 Y 275/40 R18 Y	245/35 R20 Y 275/30 R20 Y	245/45 R18 Y 275/40 R18 Y
Wheel size		8J x 18 9J x 18	8J x 18 9J x 18	8J x 20 9J x 20	8J x 18 9J x 18
Material		Light alloy	Light alloy	Light alloy	Light alloy

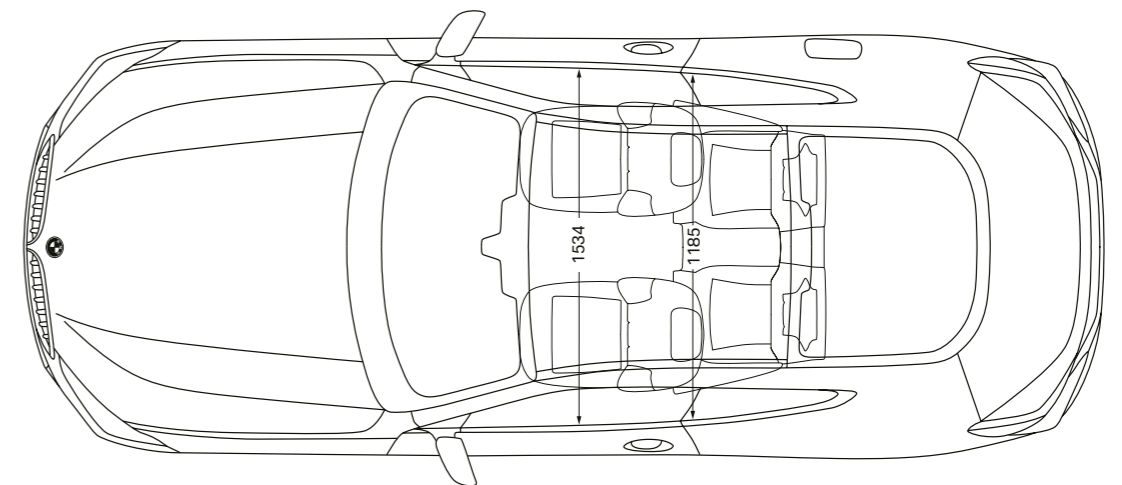
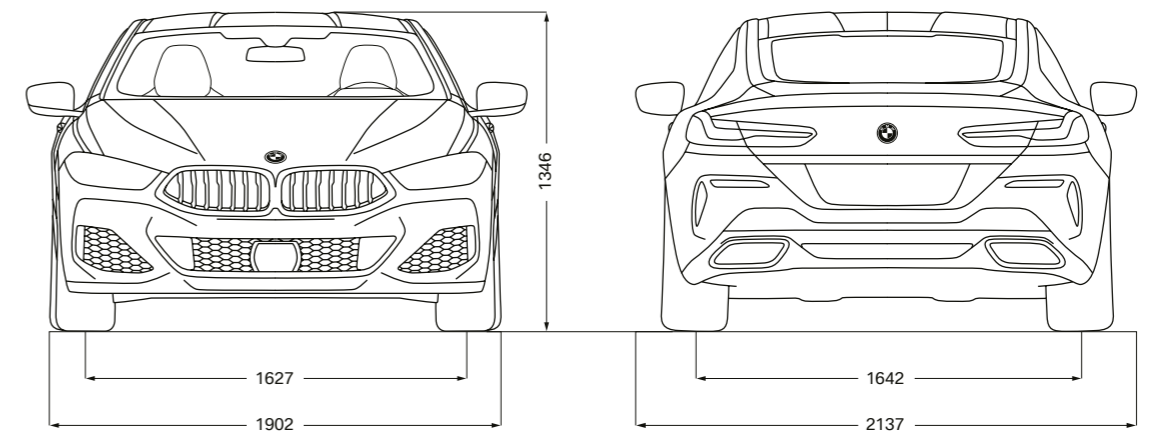
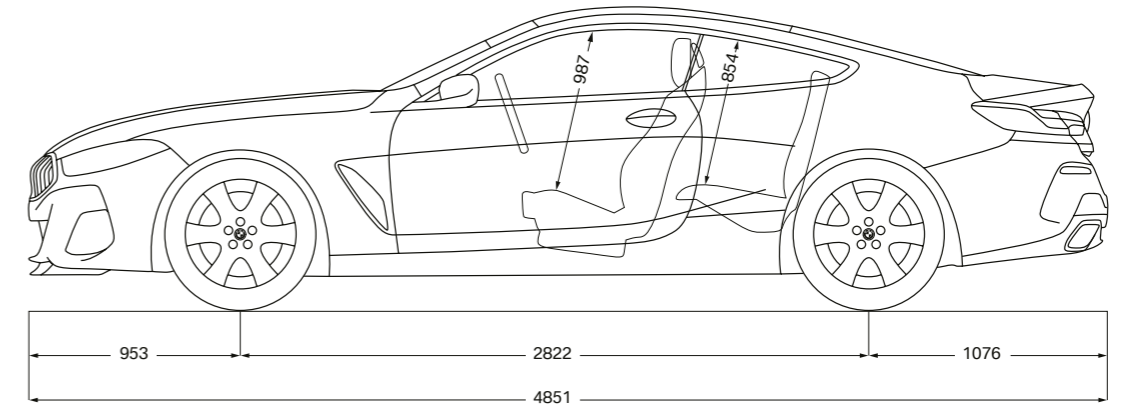

¹ The EC unladen weight refers to a vehicle with standard equipment and does not include any optional extras. The unladen weight includes a 90% full tank and a driver weight of 75 kg. Optional equipment may affect the weight of the vehicle, the payload and the top speed if the selected equipment has an impact on the vehicle's aerodynamics.

² Electronically limited.

³ Performance data of petrol engines apply to vehicles using RON 98 fuel. Fuel consumption data apply to vehicles using reference fuels in accordance with EU Regulation 2007/715. Unleaded RON 91 and higher with a maximum ethanol content of 10% (E10) may also be used. BMW recommends RON 95 super unleaded petrol.

⁴ The official data for fuel consumption and CO₂ emissions were determined in accordance with the measurements processes as defined by European Regulation (EU) 715/2007 in the applicable version. The ranges take into account differences in the selected wheel and tyre size. Figures have been determined on the basis of the new WLTP test cycle and have been converted back into NEDC figures for comparability. Values other than those specified here may apply for the assessment of taxes and other vehicle-related charges that are (also) based on CO₂ emissions.

⁵ This engine version is not available in all countries. For further information, please contact your local BMW Partner.

The dimensions in the technical drawing refer to the M850i xDrive, dimensions of the 840i, 840i xDrive and 840d xDrive may vary slightly. All dimensions in the technical drawing are given in millimetres.



The models illustrated in this medium show the equipment and configuration options (standard and optional) for vehicles produced by BMW AG for the German market. Alterations in standard and optional equipment and the configurations available for the different models, as described in this medium, may occur after 11/11/2020, the editorial deadline for this medium, or according to the specific requirements of other member states of the European Union. Your local BMW Partner is available to provide further details. Subject to change in design and equipment.

Of course, each vehicle is designed for economical recycling after its long-running life. You can find more information regarding your end-of-life vehicle on our website www.bmw.de/recycling

© BMW AG, Munich, Germany. Not to be reproduced wholly or in part without prior written permission of BMW AG, Munich.
4 11 008 022 20 1 2020 CB. Printed in Germany 2020.

BMW M850i xDrive:

BMW TwinPower Turbo 8-cylinder petrol engine, 390 kW (530 hp), 20" M light alloy wheels Y-spoke style 728 M Bicolour with mixed tyres, exterior colour in M Barcelona Blue metallic, seats in BMW Individual extended leather trim 'Merino' Tartufo/Black, Aluminium Trace dark M interior trim.

BMW M850i xDrive:

BMW TwinPower Turbo 8-cylinder petrol engine, 390 kW (530 hp), 20" BMW Individual light alloy wheels V-spoke style 730 I with mixed tyres and run-flat capabilities, exterior colour in BMW Individual Dravit Grey metallic, seats in BMW Individual extended leather trim 'Merino' Cognac, BMW Individual interior trim finishers piano finish Black.

